



TSB # 6-2020

January 2, 2020

Page 1 of 4

TO: All Bourgault Dealers
ATTN: Service Manager, Parts Manager, Sales Manager
SUBJECT: MRBIII Pivot Bearing Upgrade Kits – Special Pricing for 2020

INFORMATION BULLETIN (Information code 6.20)

Effective Serial Number Range – MRBIIIs built prior to model year 2015

BACKGROUND:

As part of annual maintenance, units with MRBIIIs should be inspected for “play” in the parallel arms. Excess movement in the pivot bushings will result in functional problems with the MRBIII as the working angle degrades. Plugging of the scraper, pre-mature scraper wear, and penetration problems will be the primary symptoms. Parallel arms that are operated for extended periods of time with excess bushing wear, will experience severe wear that may result in the parallel arm castings or the pivot body itself becoming worn and damaged beyond repair.

Reports of excess pivot bushing wear, resulting in loss of the operating angle, have been reported in some 2010 through 2014 MRBIIIs. The investigation has concluded that one or more of the following factors were at issue:

1. Inconsistent manufacturing of the pivot bores
2. Undersized bushings
3. Damage to bushings during installation
4. Operation of the MRBIII at too low of an operating pressure resulting in excess tripping out of the MRBIII (see TSB 21-2013)

CORRECTIVE ACTION:

- All MRBIII parallel arm pivot bushings should be inspected seasonally for wear.
- It is strongly recommended that MRBIIIs be inspected prior to the next season of use.
- It is recommended that parallel arm pivot bushings showing 7/16” of “side to side” movement, as measured at the top of the disc when in the raised position, be repaired to avoid potential performance problems.
- If re-work is required, reference the table on page 2, for information on the needle bearing retrofit kits. Please note that due to the potential variability in the machined bores, the needle bearing and greaseable pin design used on 2015 and newer MRBIIIs is being utilized given it is the most effective solution.
- Inspection and repair procedures can be viewed at www.bourgault.com and on the Bourgault U-Tube channel.



TSB # 6-2020

Page 2 of 4

SUBJECT: MRBIII Pivot Bearing Upgrade Kits– Special Pricing for 2020

Part Number	Qty. per MRB3	Description	Ref Price	List Price
6726-95	4	MRB3 Needle Bearing Retrofit Kit		
6726-37	1 / left	Zerk Shield – pivot A – see drawing page 3		
6726-38	1 / right	Zerk Shield – pivot A – see drawing page 3		
9313-82	1 / left or right	Zerk Shield – pivot B – see drawing page 3		
9313-88-26	1 / unit	Assembly bullet – strongly recommended		
9313-88-25	1 / unit	Bearing Installation Sleeve - needed		

Special parts pricing is in effect, pricing is subject to change without notice.

WARRANTY DETAIL:

Special parts pricing remains in effect for the 2020 season – CALL DEALER FOR PRICING

- **Model Year 2015 and newer**
 - Not applicable as all 2015 model year machines and newer are equipped with needle bearings.
- **Units past the 5th year of warranty** – currently model year 2014 and older.
 - Will be able to purchase the retrofit kits at the special pricing.

TSB # 6-2020

Page 3 of 4

SUBJECT: MRBIII Pivot Bearing Upgrade Kits– Special Pricing for 2020

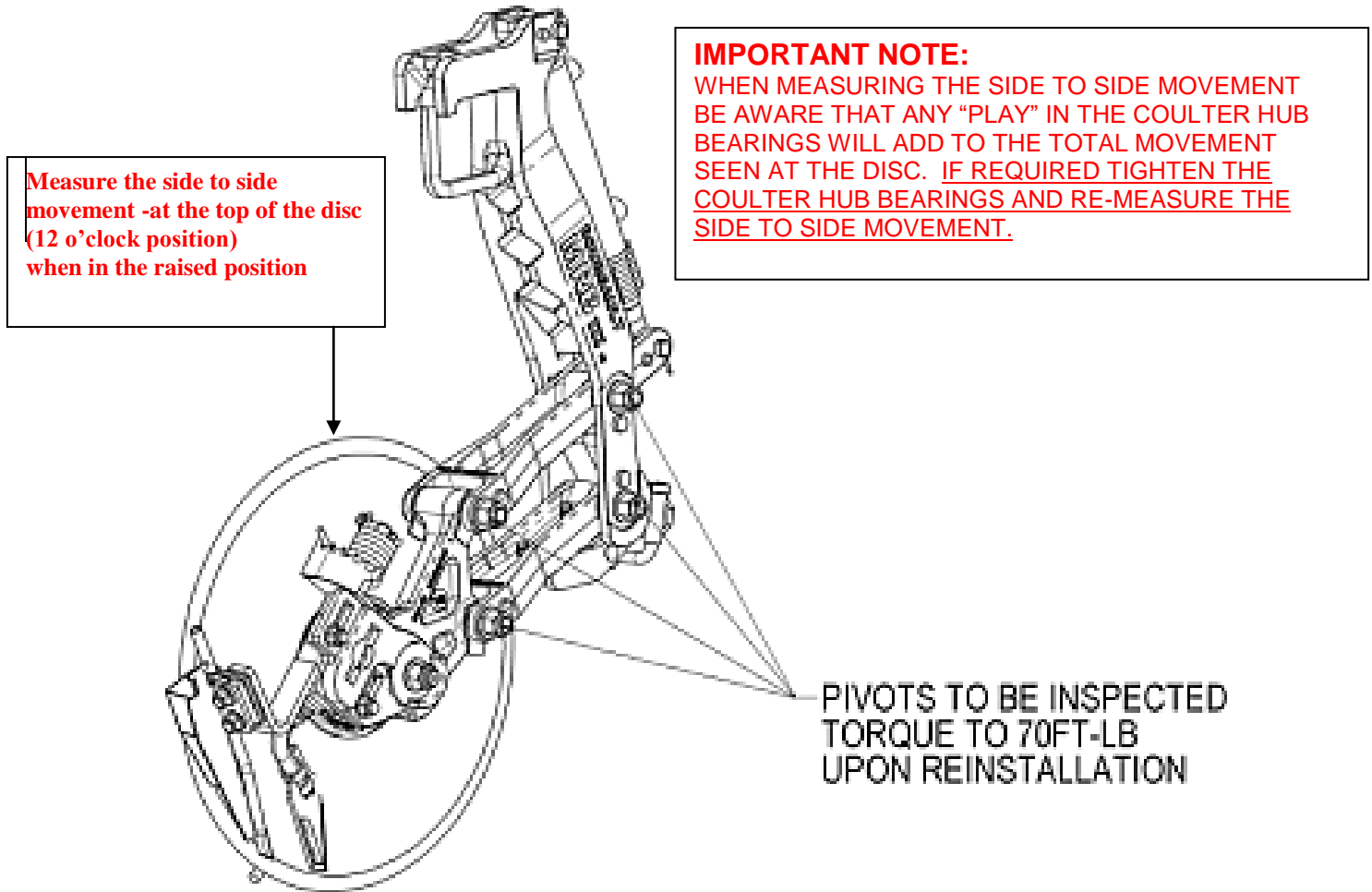







TSB # 6-2020

Page 4 of 4

SUBJECT: MRBIII Pivot Bearing Upgrade Kits – Special Coverage for 2020

ITEM #	PART #	DESCRIPTION	QTY.
1	1207-07	NUT PTRQ TL 3/4 UNC GR B CDW	1
2	1325-39	WSHR 3/4 SAE PLD	1
3	2110-07-01	BRG NEEDLE 1-1/4X1X1 FULL COMP	2
4	2401-47	SHIM 1/8X1IDX2OD	2
5	2450-53	SEAL 1-1/4X1X1/8 SKF CR9815	2
6	6726-36	PIN PVT MRB3 FORGED GREASE	1

 <p>ORDER 1 IF REPLACING PIVOT A LEFT HAND CONFIGURATION</p>	 <p>ORDER 1 IF REPLACING PIVOT A RIGHT HAND CONFIGURATION</p>
 <p>6726-37 SHLD ZERK MRB3 PIVOT L</p>	 <p>6726-38 SHLD ZERK MRB3 PIVOT R</p>
 <p>ORDER 1 IF REPLACING PIVOT B, EITHER CONFIGURATION</p>	 <p>9313-82 SHLD ZERK 3720 PIVOT</p>

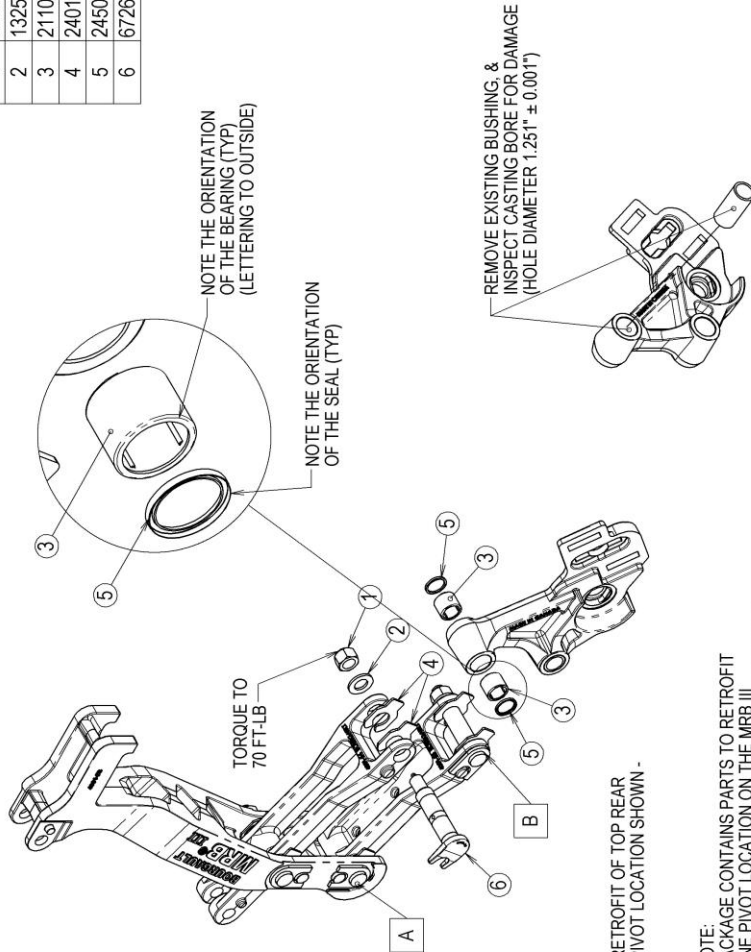

- RETROFIT OF TOP REAR PIVOT LOCATION SHOWN -

NOTE: PACKAGE CONTAINS PARTS TO RETROFIT ONE PIVOT LOCATION ON THE MRB III ASSEMBLY WITH BEARINGS AND GREASABLE PIN. (ORDER ONE PKG FOR EACH PIN TO BE REPLACED.)

NOTE: SPECIALTY HAND TOOLS (IF REQUIRED) AVAILABLE FROM PARTS 9313-88-20.

REV	DATE	DESCRIPTION	CB	BY
1	22-Jul-14	ADDED NOTES REGARDING ZERK SHIELDS	14-382	DML
0	18-Dec-13	COMPLETED DRAWING	13-805	KST

DATE	DRN BY	KST	SCALE	SIZE	PAGE
18-DEC-13			1:8	A	1 OF 1

DOCUMENT NO.	WEIGHT	COLOR
6726-95	1.5 LB	NONE

BOURGAULT INDUSTRIES LTD.
ST-BRIEUX, SASKATCHEWAN, CANADA S4K 3R0

PKG MRB3 RETRO NEEDLE BRG

TOLERANCES UNLESS OTHERWISE SPECIFIED:
 ANGLES ± 1° FRACTIONS ± 1/16"
 DECIMALS FRACTIONAL HOLES:
 .XX ± 0.1"
 .XXX ± 0.05"
 A: -0.020", -0.010"
 B: +0.150", -0.010"

THE INFORMATION CONTAINED IN THIS DOCUMENT IS THE SOLE PROPERTY OF BOURGAULT INDUSTRIES LTD. USE SHALL BE LIMITED TO THE PURPOSES FOR WHICH THE INFORMATION HAS BEEN PROVIDED. ANY REPRODUCTION OR DISCLOSURE TO THIRD PARTIES, IN WHOLE OR PART, WITHOUT THE WRITTEN PERMISSION OF BOURGAULT INDUSTRIES LTD. IS PROHIBITED.